

Partition FIBRAN SuperCARE 125/75 mw

Partition drywall $R_w = 59$ dB - EI120 - thickness 125 mm

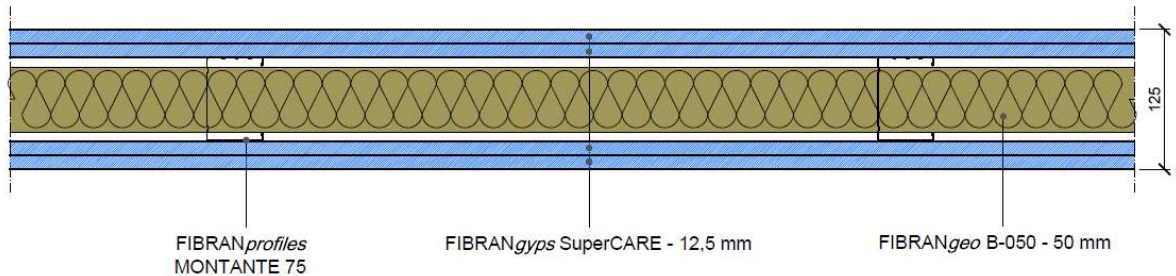

COMPONENTS

Plasterboards

2 layers of **FIBRANgypS SuperCARE** both side, thickness **12,5 mm**, produced with a new technology which can neutralize most of the VOCs present in the environment. It's CE marked– **type D, I, F, H1, R** according to EN 520, classified **A+** according to EN ISO 16000-09, fire reaction **A2-s1,d0** according to EN 13501-1, controlled density more than 1000 kg/m^3 , enhanced surface hardness, improved core adhesion at high temperature, reduced water absorption rate (total $<5\%$; surface 180 g/m^2), higher strength (flexural breaking load $> 725 \text{ N}$), weight $12,7 \text{ kg/m}^2$, water vapor resistance factor $\mu=10$, thermal conductivity $\lambda=0,25 \text{ W/m K}$ and specific heat $c_p=1,03 \text{ kJ/kg K}$ according to EN 10456



Metal frame thickness 0,6 mm conform to EN 14195

Channels **FIBRANprofiles GUIDA 75** mechanically fixed to the floor and ceiling using fixing nails at a maximum spacing of 500 mm;

Studs **FIBRANprofiles MONTANTE 75**, max axial spacing every 600 mm, slotted to allow passage of the installations

Insulation board in cavity

FIBRANgeo B-050, biosoluble stone wool board, density 50 kg/m^3 , thickness **50 mm**, fire reaction A1 according to EN 13501-1, thermal conductivity 10°C $\lambda_p=0,034 \text{ W/m K}$ according to EN 12667 and EN 12939, water vapour diffusion resistance factor $\mu= 1$ according to EN 12086, specific heat capacity $c_p = 1.03 \text{ kJ / kg K}$ according to EN 10456

Screws

Self-drilling screws **FIBRANgypS SCREW SUPER 3,9 x 23 and 3,9 x 38 mm** fixed max 150 mm each

Adhesive tape and joint filler

Closed cell polyethylene foam adhesive tape **FIBRANgypS** to be applied on the entire perimeter of the metal structure, to eliminate the possible acoustic bridges due to the transmission of noise through the building structures.

Treatment of the joints between plasterboards and head of screws with **FIBRANgypS JF**, CE marked 3B according to EN 13963, and reinforcing tape **FIBRANgypS TAPE** according to the level quality Q2 (Eurogypsum)

Partition FIBRAN SuperCARE 125/75 mw

Technical features

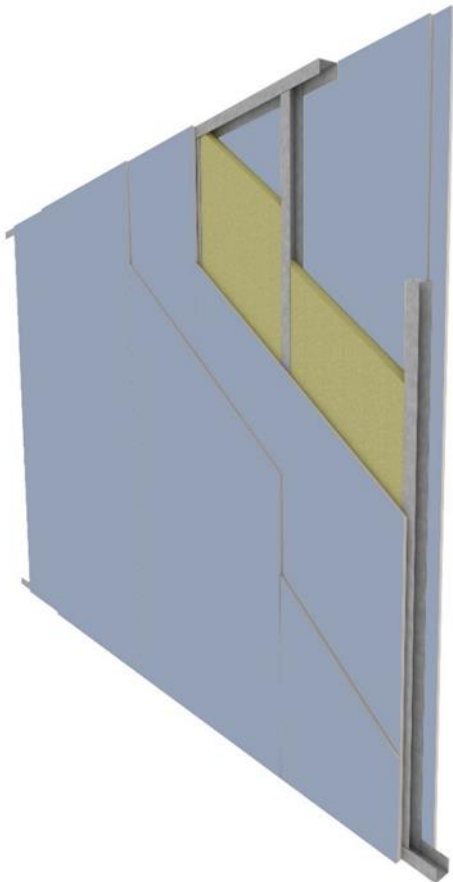

Acoustics

R_w = 59 dB – test report Istituto Giordano n° 324834

Fire rating

Fire rating: EI 120 (Classification Report LAPI 103/C/12-160FR according to EN 1364-1)

Max height: 17,50 m with technical dossier

Thermal Insulation

U = 0,59 W/m²K – calculated with software

Mechanical performance

FIBRANprofiles channels and studs DIN 75 mm, max axial spacing every 600 mm, thickness 6/10 mm conform to EN 14195.

Profiles must be designed according to local regulation and specific application.

In case of walls longer than 15 meters, an expansion joint must be made every 10 meters or at structural joints

Finishing

According to quality level required (Eurogypsum). Use FIBRANGyps JF READY MIX for level Q4

Sustainability

FIBRANGyps plasterboards are classified A+, the best one according to EN ISO 16000-09, with regards to the emission of formaldehyde, acetaldehyde and other substances

Quality of air

The new technology CARE transforms formaldehyde into inert substance, without releasing it back into the environment

Impact resistance hard body





According to ETAG 003, non-load bearing partition walls, 1 kg steel sphere falling 10 times from different heights from 60 to 160 cm (equal to 6 Nm) without any surface damage- passed

Impact resistance soft body

According to ETAG 003, non-load bearing partition walls, 50 kg bag falling 3 times from different positions from 174 cm height (equal to 120 Nm) without any functional damage- passed

Partition FIBRAN SuperCARE 125/75 mw

Technical features

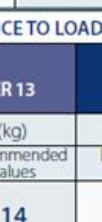
FLEXURAL BREAKING LOAD						
	FIBRANgypS A13	FIBRANgypS SUPER 13	FIBRANgypS A15	FIBRANgypS SUPER 15		
Longitudinal flexion EN 520	> 550 N	> 725 N	> 650 N	> 870 N		
Transversal flexion EN 520	> 210 N	> 300 N	> 250 N	> 360 N		
RESISTANCE TO LOADS*						
FIXINGS	1 layer FIBRANgypS SUPER 13		2 layers FIBRANgypS SUPER 13		2 layers FIBRANgypS SUPER 13	
	Shear strength (kg)		Shear strength (kg)		Traction (kg)	
	Laboratory values	Recommended values	Laboratory values	Recommended values	Laboratory values	Recommended values
Nail 	36	14	-	-	-	-
Metallic dowel "Gold" 	-	-	80	32	60	24
Metallic dowel "Molly" 	120	48	180	72	150	60
ECCENTRIC LOADS RESISTANCE *						
		Loading test on shelf Shelves loaded up to 48 kg can be fixed directly to double layer of FIBRANgypS SUPER, using metallic dowels Molly at maximum distance of 50 cm. The result of the laboratory test is 120 kg.				48kg
* Recommended values obtained by applying to the test values a safety coefficient of 2,5 (as required by UNI 13964). Test report n°137. by Tecnolab di Napoli and test reports n°327335/n°3273336 by Istituto Giordano of Bellaria.						

Partition FIBRAN SuperCARE 125/75 mw Construction details

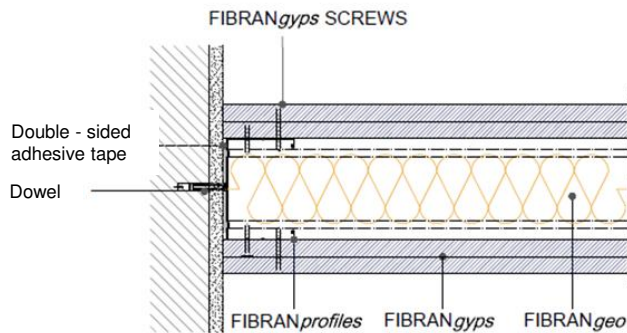

Detail. 1 **WALL CONNECTION**

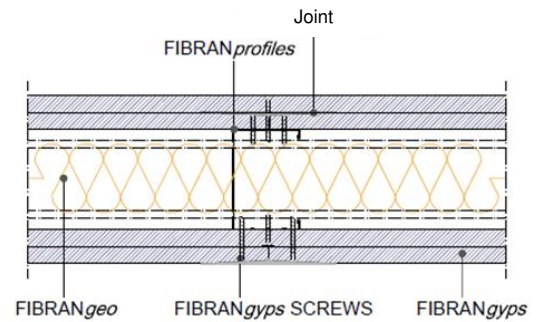

Detail. 2 **JOINT**

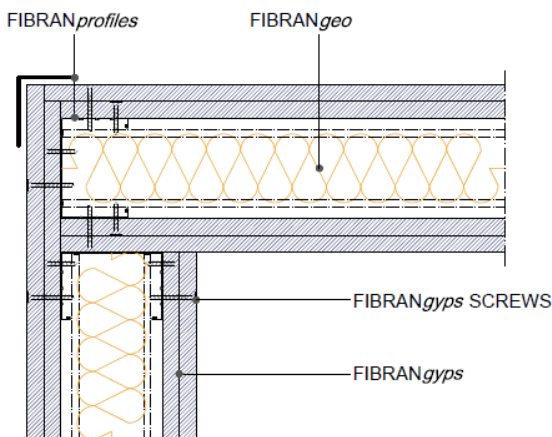

Detail. 3 **CORNER FITTING**

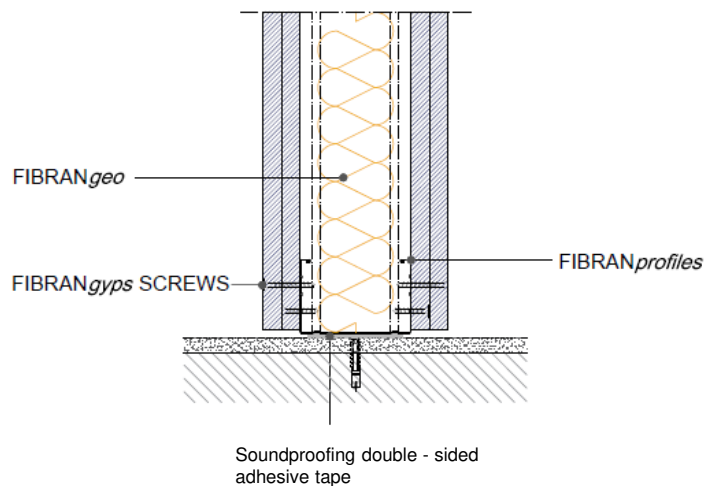

Detail. 4 **FLOOR CONNECTION**

Partition FIBRAN SuperCARE 125/75 mw Construction details

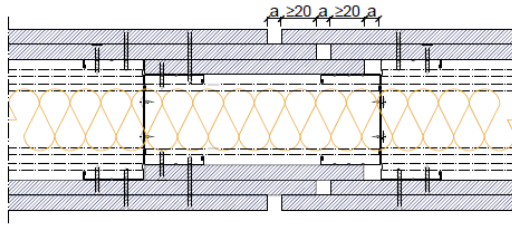

Detail. 5 **EXPANSION JOINT**

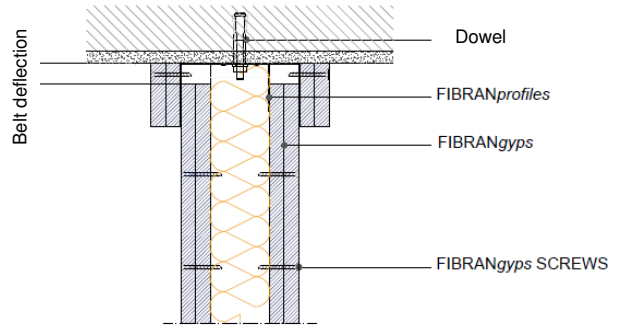

Detail. 6 **DESOLIDARIZZAZIONE FLOOR - WALL**

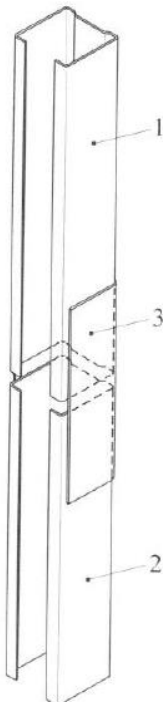

LEGEND



- 1. stud
- 2. stud
- 3. stiffening element made with a channel of the same width as the stud; lenght at least 10 times the width

Detail. 7 **JOINT BETWEEN PROFILES**

Partition FIBRAN SuperCARE 125/75 mw

Quantities of material

Indicative quantities for square meter of partition

		quantity/m ²		quantity/m ²	
		centre 600 mm		centre 400 mm	
Description	UM				
FIBRANgyps	m ²	4,2	4,2	4,2	4,2
FIBRANprofiles studs	m	2	4	2,6	5,2
FIBRANprofiles channels	m	0,7	0,7	0,7	0,7
FIBRANgeo	m ²	1,05	1,05	1,05	1,05
Joint filler FIBRANgyps JF	kg	0,7	0,7	0,7	0,7
Adhesive tape FIBRANprofiles	m	1	1	1	1
FIBRANgyps TAPE	m	1,67	1,67	1,67	1,67
FIBRANgyps SCREWSUPER 23mm	pz	20	20	25	25
FIBRANgyps SCREW SUPER 38mm	pz	25	25	30	30